

Article number: 2035024517554ST

Description: E+G Levelling sets GN 350.2-45-17.5-54-ST

Measures

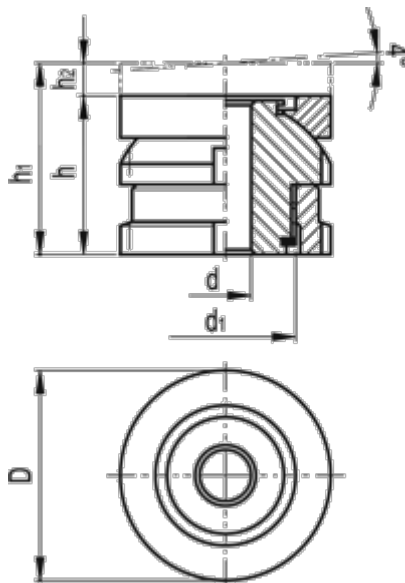

C-spanner DIN 1810 = A45-50

d = 17.5

D = 45

d1 = M30x1.5

For screw = M16

h = 54

h1 = 79

h2 = 7

Max static load (kN) = 84

Static preload (kN) = 28.9

Weight (g) = 513